



BLS Series- LED Square Bollard Installation Guide

⚠ WARNING

RISK OF FIRE, ELECTRIC SHOCK, INJURY OR PROPERTY DAMAGE.

- Risk of electric shock--Disconnect power to equipment before installing or servicing. This equipment must be installed according to all applicable codes & ordinances.
- Installation and service of this equipment must be performed by qualified service personnel.
- Read these instructions before installing, servicing or maintaining this equipment.
- Save these instructions for maintaining and servicing.
- The installer must ensure that the foundation is stable and can support the luminaire's weight.
- The Installer must use proper means to secure the luminaire to the ground.

⚠ CAUTION

- Edges may cut--wear gloves while handling or servicing this equipment.
- Inspect equipment for damage from shipping and handling.
- Recommended cleaning substances:
- Wipe off dust with a dry, soft cloth. Remove greasy spots etc. with a soft cloth dampened in lukewarm water (<math><122^{\circ}</math> F/ 50° C) with a mild detergent.
- Never use detergents containing abrasives and solvents.
- Warning: Scouring powder and similar substances will scratch surfaces.

LUMINAIRE PREPARATION

Remove the luminaire (Fig 1) and accessories (Fig 2) from the carton and inspect luminaire for damage. Do not install a damaged luminaire.

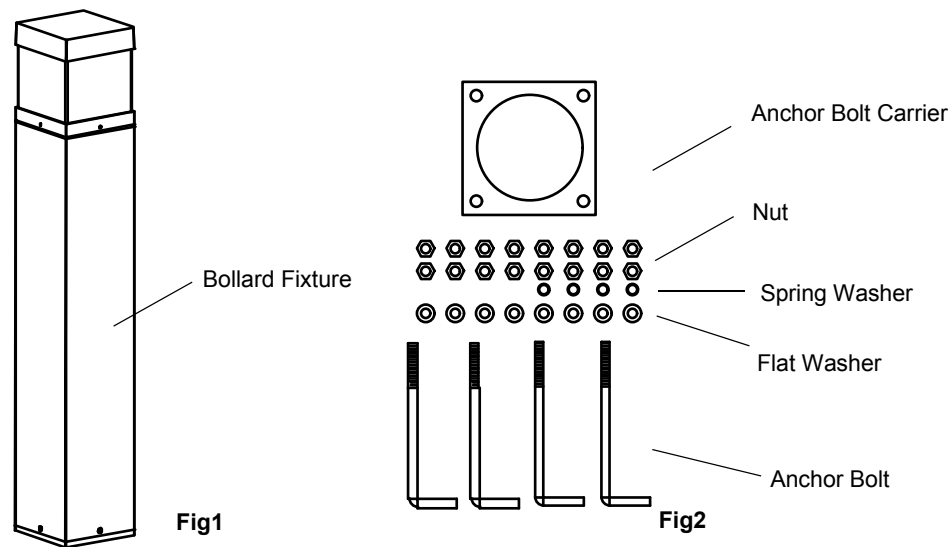

INSTALLING BOLLARD

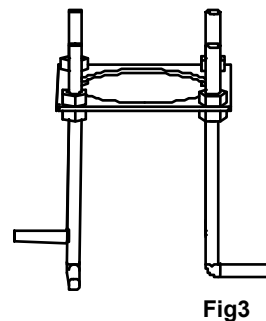

- Prepare site. Get the anchor bolt carrier assembled as Fig3 and use it to determine placement of anchor bolts in concrete.
- Ensure that concrete base is suitable for the bollard load.
- Install four anchor bolts into concrete as per attached drawing, having at least 1-1/2~2" protruding from concrete with threads free and clear of debris and dirt.

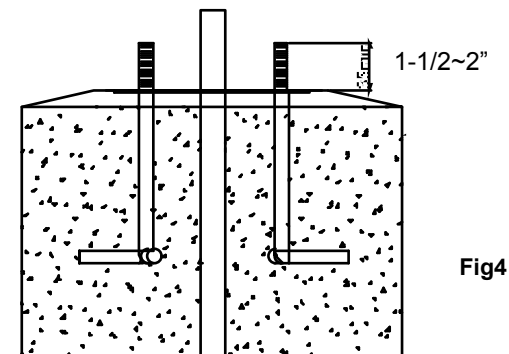

- Dis-assembly the fixture by loosening the set screwsx4 with hex wrench. (Fig5)
- Lay the fixture down by the side of the installed anchor bolts. Keep the wires connected.

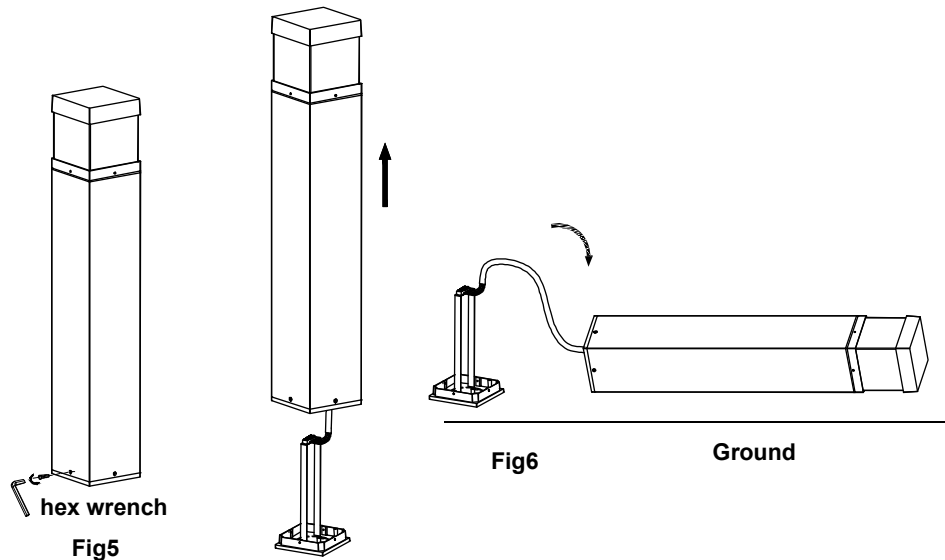

- Place bollard base plate over anchor bolts and tighten nuts securing the base plate to the foundation.
- As the wires shown on Fig7 will not be disconnected during installation, so please double check to make sure they are in good connection after the base installation.

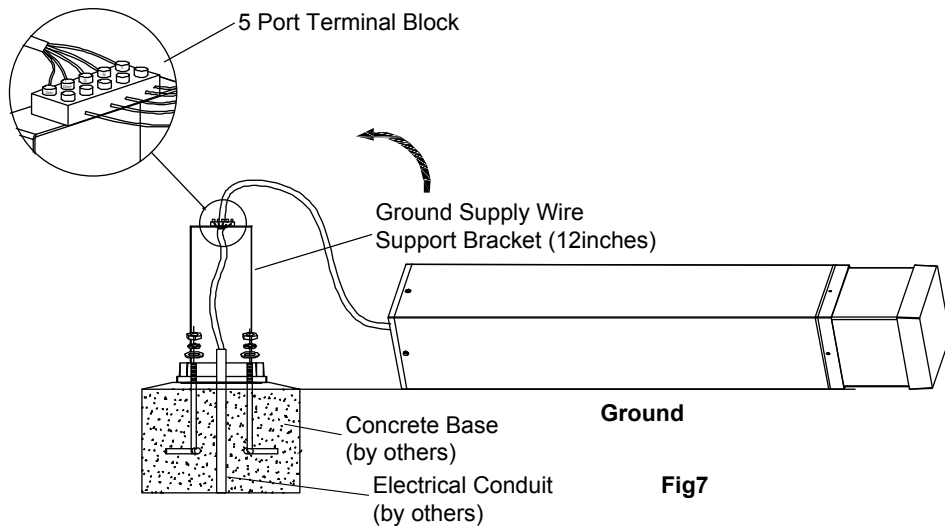

Put back the fixture body, and tighten the set screwsx4 with hex wrench. (Fig8)

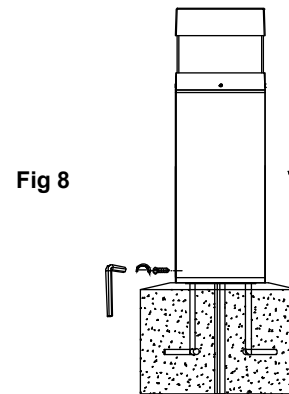

BOLLARD ANCHOR BOLT GUIDE

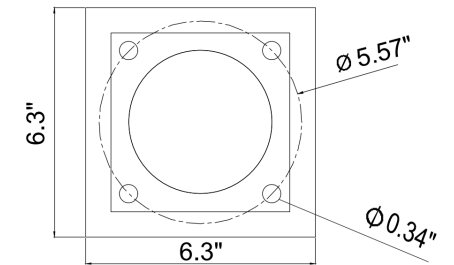

DIAL SWITCHES DIAGRAM

Loosen 4 screws, open the top of the fixture

Dial Switches for Watt & CCT Selection

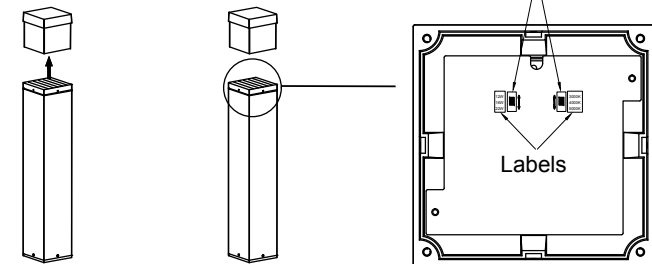

WIRING DIRGRAM

Supply Line	⓪ ⓪	Black Wire
Supply Neutral	⓪ ⓪	White Wire
Supply Ground	⓪ ⓪	Green Wire
0-10V Dim+	⓪ ⓪	Purple Wire
0-10V Dim-	⓪ ⓪	Gray Wire

Fig 10

